



MRT 125 LC

EURO 5



OWNER'S MANUAL



RIEJU S.A. would like to thank you for your trust in our company and congratulate you on an excellent choice.

The **MRT 125 LC Euro 5** model is the result of **RIEJU**, extensive experience in developing high-performance vehicles.

The purpose of this Owner's Manual is to set forth how to use and maintain your vehicle. We ask that you carefully read the instructions and the information provided as follows.

Please remember that the vehicle's lifespan depends on how you use and maintain it. Keeping it in perfect operating condition reduces the cost of repairs.

Please consider this manual an integral part of the vehicle. It must remain with its basic equipment, even in the event of a change in ownership.

For any issues, please see your **RIEJU** dealer, who will be delighted to serve you, or visit **www.riejumoto.es**

Remember that for your vehicle to operate properly, you must always request original replacements.



CONTENTS

Vehicle description	6	Selection button	28
Vehicle registration	7	Using the stopwatch	28
Vehicle delivery	8	Speed log	28
Prior vehicle inspection	9	Settings	30
Technical data	12	Wheel diameter and number of pulses	30
Location of serial numbers	14	Odometer "B"	32
Main vehicle elements	16	Signals	33
Clutch lever	18	TOTAL (Odometer or ride time)	35
Front brake lever	18	Trip A / Trip B (Distance or ride time)	36
Handlebar switches	19	Clock	38
Blinker switch	19	Ride Time	39
Horn button	20	Unit option selection (km or mi)	40
Light switch	20	Wheel length display	41
Start-up button	21	Fuel level	42
Lock	22	Coolant high temperature	43
Odometer "A"	23	OBD indicator	43
Signals	24	Front suspension	44
Adjustment button	26	Rear suspension	44
Km/mile selection	26	Rear brake pedal	45
Using TRIP (partial route)	26	Gearshift pedal	45
Total time	27	Kickstand	46
Partial times	27	Fuel tank	47



Tyres	48	Cooling system	67
Battery	49	Spark plug	68
Driving	50	Crankcase oil - checking and filling	69
Starting up the engine	51	Air filter	71
Acceleration	53	Steering set	73
Braking	53	General lubrication	74
Stopping	53	Maintenance table	75
Driving	54	Cleaning and long-term storage	77
Maintenance	55	Cleaning	77
Transmission chain (adjustment and tension)	55	Long-term storage	78
Front headlight bulb	56	Warranty	79
Position lamp bulb	58		
Rear light	58		
Plate light	59		
Brakes	60		
Front brake - adjusting lever distance	61		
Rear brake - adjusting pedal distance	61		
Front brake fluid level	62		
Rear brake fluid level	63		
Clutch - Adjustment	64		
Fuel line - Adjustment	65		
Brake pads	66		



VEHICLE DESCRIPTION

This motorcycle has a four-stroke single-cylinder engine with water cooling. Its cubic capacity is 125 cubic centimetres, with a 58-mm diameter piston with 47 mm movement.

It is turned on with an electric wheel and 140 W AC spool.

Steel and friction multi-plate clutch with constant pressure springs, immersed in oil bath.

The engine is anchored to a highly resistant perimeter chassis, with cone roller bearings.

The front suspension is a hydraulic fork with 37-mm diameter bars. Rear suspension is a hydraulic mechanical shock absorber that provides gentle operation.

The front and rear brakes are stainless steel disc brakes. The front measures 260 mm and the rear 200 mm.



VEHICLE REGISTRATION

Please make a note of the chassis and engine serial numbers, which will help you for all purposes (certificate of characteristics, insurance, registration, etc.).

These numbers will be useful for you for any suggestions or complaints, as well as to order replacement parts.

Chassis serial number (p.12)

Engine serial number (p.12)

Dealer seal



VEHICLE DELIVERY (complete upon first delivery)

- USER MANUAL**
Explain the importance of reading it and understanding all the information. Highlight the sections on safety and maintenance practises.
- WARRANTY REGISTRATION CARD**
Complete the necessary information and provide the customer with a copy.
- HANDLING**
Explain how to properly handle the vehicle.
- WARNINGS**
Explain the importance of the warnings to guarantee a long “life” for the vehicle.
- KEYS**
Deliver the complete set. Advise them to make a backup set.
- FIRST INSPECTION**
Explain that an inspection after 1,000 km is important.
- PERIODICAL MAINTENANCE**
Explain the need for periodical maintenance and state that failure to comply with guidelines for check-up and visiting the shop is grounds for “Loss of Vehicle Warranty”.



INSPECTION PRIOR TO DELIVERY (Adjustments)

General appearance

Engine

- Engine oil level

- Emptying the carburettor float chamber

Chassis

- No fuel leaks in: Tank output, fuel tap, and supply lines

- Front and rear brake - Drain, if necessary

- Coolant level, if applicable

- Front, rear mudguard and attachment elements

- Wiring of electrical installation around the steering column

- Alignment of front, rear wheels, and tightening torque of wheel axles

- Spokes of front and rear wheels

- Tyre pressure

- Chain tension

Checking the equipment

- Accelerator works and has free play. Adjust if necessary

- Degrease both brake discs

- Battery charged and terminals greased

- Block steering or anti-theft block



- Electric start-up and kick starter (depending on model) engine operation
- General condition of front and rear suspension
- Clutch cable properly adjusted
- Operation of fuel cap closure
- General inspection of nuts and screws: Callipers/discs, transmission/pinions, wheel nuts, tilt, engine mounts, exhaust system, shock absorber, gear selector, brake pedal/levers, manifold nuts, etc.

Fuel tank

- Check that the tank is not in contact with the frame

Driving components

- The digital instrument dashboard checks itself when the ignition is turned on (depending on the model)
- Adjusting the headlight height
- Brake light when pressing brake levers LH and RH
- Front, rear blinkers and mounting clips
- Horn operation

ON-ROAD TEST, at least 10 km

- Engine and gearbox operation
- Grip on road and suspensions
- Braking and ABS operation (if installed)
- No abnormal sounds



AFTER ON-ROAD TEST

- Carburettor needle, adjust if necessary (if a carburation model)
- Coolant leaks
- Fuel system, including hoses, clips, and all associated parts where leaks may appear
- Check breakdown codes with diagnostic tool and delete them if applicable (depending on the model)
- CHECKING FINAL APPEARANCE**

Date

Manufacturer signature



TECHNICAL INFO

GENERAL INFORMATION	ENDURO / SUPERMOTARD
Fuel	Unleaded petrol E5
Oil filter	Paper
Oil pump	Mechanical
Water pump	Single-suction centrifugal pump
Spark plug - Spark area	NGK/CR8E (0.6-0.7 mm (0.028-0.031"))

SIZES	ENDURO	SUPERMOTARD
Distance between axles	1.405 mm	1.405 mm
Length	2.148 mm	2.148 mm
Height	1.165 mm	1.165 mm
Width	800 mm	800 mm
Saddle height	896 mm	870 mm
Dry weight	112 Kg	112 Kg
Fuel tank	6 L	6 L



CHASSIS	ENDURO	SUPERMOTARD
Chassis	High-resistance steel perimeter twin spar Removable rear sub-chassis	
Front suspension	Fork Ø37 mm	
Rear suspension	Mono-shock shock absorber	
Front tyre	80/90-21"	100/80-17"
Rear tyre	110/80-18"	130/70-17"
Front brake	Ø260 mm disc	
Rear brake	Ø200 mm disc	

ENGINE	ENDURO / SUPERMOTARD
Type	4t - 125 c.c. 4 Injection Valves
Diameter x Span	58 x 47 mm
Shift	6-Speed. Foot shifter
Cooling	Water
Start-up	Electric
Lubrication	Flooded body
Oil type	10W40 GRO
Amount of oil	
Without replacing oil filter ensemble	0,95 l (1,00 US qt) (0,84 Imp. qt)
With replacement of the oil filter	1,00 l (1,06 US qt)(0,88 Imp. qt)



LOCATION OF SERIAL NUMBERS

Chassis identification number

This is the number (1) that is die-cut on the right of the steering tube.

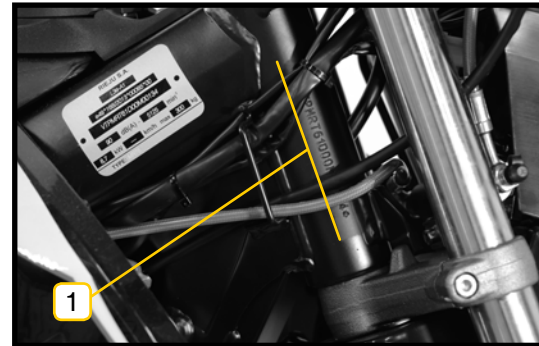

Engine identification number

This is the number (1) that is marked on the bottom of the engine's left crankcase half.

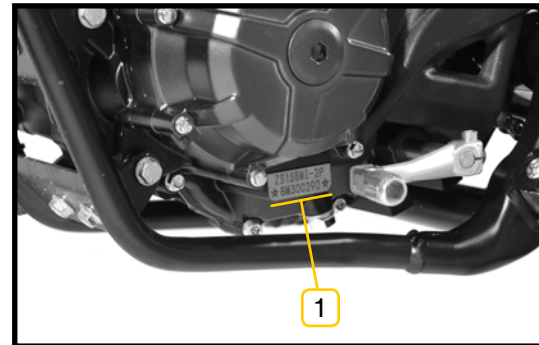



Builder label

Your **RIEJU** has an identification plate (1) with details on: manufacturer, frame number, approval number, and sound emissions level.

The frame number is also die-cut on the right side of the steering tube.





MAIN VEHICLE ELEMENTS

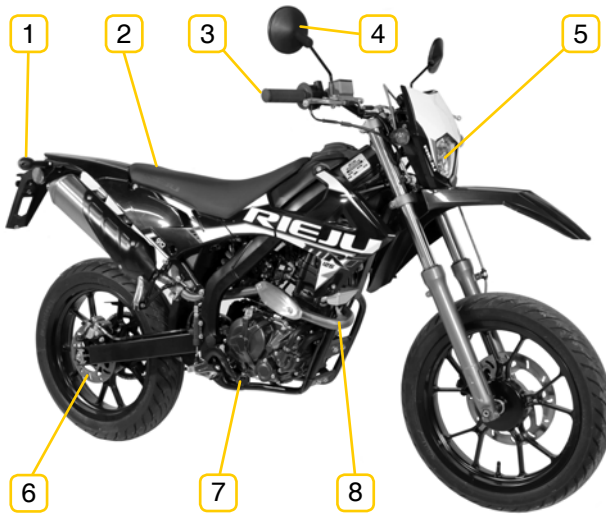

- 1- Rear blinkers
- 2- Saddle
- 3- Gas grip
- 4- Right rear-view mirror
- 5- Front headlight

- 6- Rear brake disc
- 7- Rear brake lever
- 8- Exhaust
- 9- Front blinkers
- 10- Left rear-view mirror

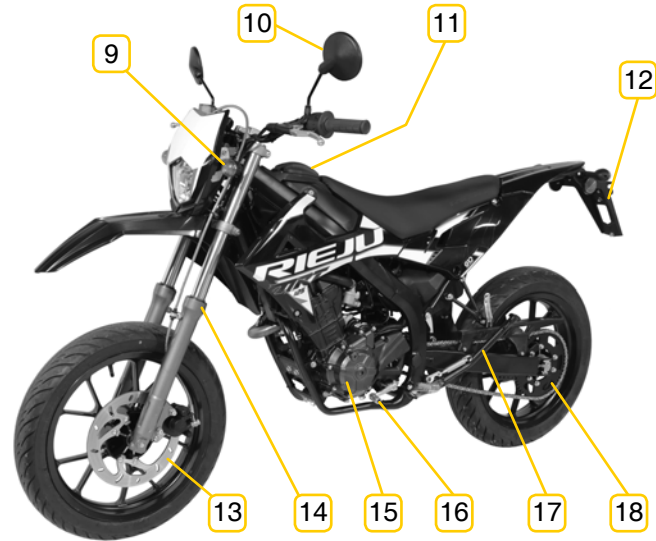

- 11- E5 fuel tank cap
- 12- Plate holder
- 13- Front brake disc
- 14- Front suspension
- 15- Engine

- 16- Gearshift lever
- 17- Kickstand
- 18- Transmission chain

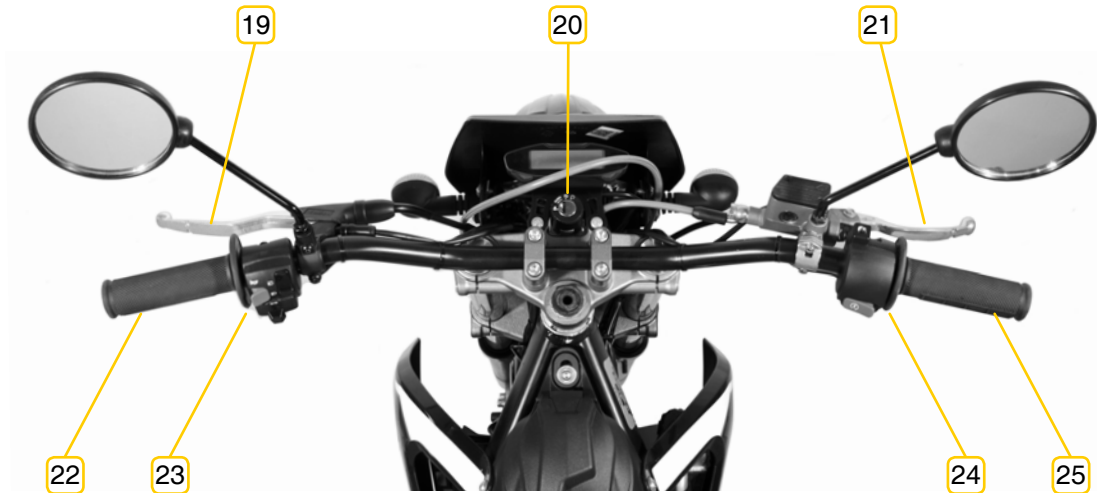

19- Clutch lever

20- Lock

21- Front brake lever

22- Left grip

23- Light/steering/horn controls

24- Start-up controls

25- Gas grip



CLUTCH LEVER

The clutch lever is located to the left of the handle.
To activate it, press the lever toward the grip.



FRONT BRAKE LEVER

The front brake lever is on the right of the handle.
To activate the brake, press the lever toward the grip.





HANDLEBAR SWITCHES



Blinker switch

There are three positions:

A - Deactivated in the central position.

B - In the right-hand position when you must turn to the right.

C - In the left-hand position when you must turn to the left.

Ensure that the button always returns to its central position.

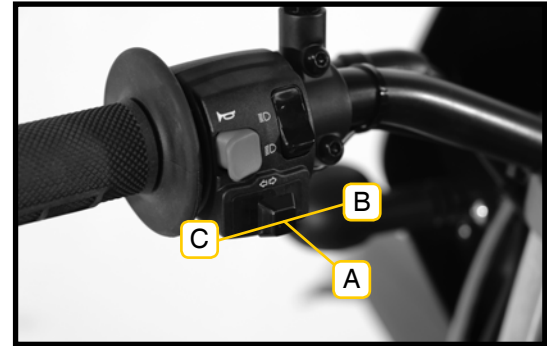

TIP: After turning, do not forget to put the switch in its central position by pressing the button.



Horn button

Activate the button to honk the horn (D).



Remember that it is forbidden to use loud noise signals for reasons not permitted by regulations.

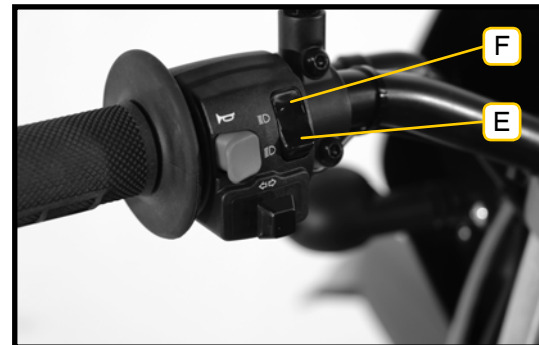

Light switch

It has two positions:



In the bottom position, the light is set to low beam (E).



In the upper position, the light is set to high beam (F).



Start-up button

To start up the engine, press the switch (G). Check before doing so that the gear lever is in neutral.

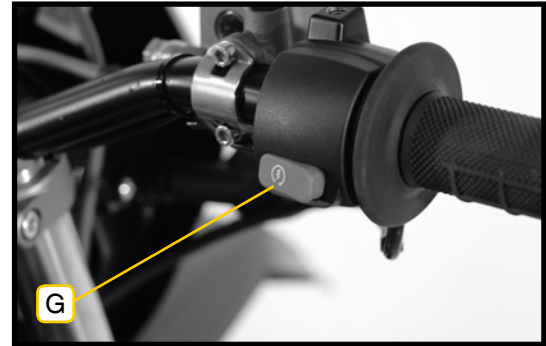



LOCK

The lock is in the middle of the handlebar, between the handlebar and the speedometer.

With the lock, you can control the vehicle's start-up and block the handlebar.

On/Off

1- Put the key in  position.

Blocking/unblocking the handlebar

1- Turn the handlebar all the way to the left.

2- Put the key in  position.

3- Press the key and turn it to  position.

4- Remove the key.



Electric system connection.



Electric system disconnection.



Blocking steering and disconnecting the electric system.



ODOMETER "A"

Signals

Left blinker
Neutral
Engine failure
High beams

Speedometer

Km/h or MPH units

Timer

Speed log:

Average speed and maximum speed

Signals

Right blinker
Engine oil
Fuel level

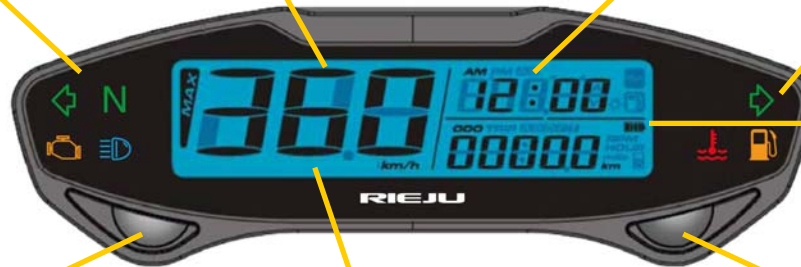

Voltmeter

Viewing range
4 levels

Selection Button

Press the Selection Button on the main screen to change between clock mode, speed log, stopwatch, and maximum speed.

Odometer

Viewing range: 0-9999 km (miles). It automatically restarts after 99999 km (miles).
Viewing unit: 1 km (mile)

Partial odometer

Viewing range: 0-999.9 km (miles). It automatically restarts after 999.9 km (miles).
Viewing unit: 0.1 km (mile)

Adjustment Button

Press the Adjustment Button on the main screen to change between ODO, Trip A/B, Total time, and partial times A/B.



Signals



“Neutral” gear light

This light lights up when the gear lever is in neutral.



Engine temperature light

This light is very important, because it tells us when the engine is too hot. This excess temperature may be due to several different factors.



CAUTION: You must not drive when this light is on since it can cause serious harm to the engine. Go as soon as possible to your RIEJU dealer.



“High beam” light

This light turns on when your vehicle’s “high beams” are on.



Blinker light

This light turns on when you have selected blinker lights (right or left).



Engine failure light

The engine failure light indicates that a parameter in the carburation or engine turn-on system is incorrect.

The light may blink a few times when the ignition turns over; this is not due to any breakdown.



CAUTION: You must not drive when this light is on since it can cause serious harm to the engine. Go as soon as possible to your RIEJU dealer.



Fuel light

The light turns on when the fuel level is below the reserve. Fill the tank as soon as possible to avoid running out of fuel.



Adjustment button

Km/mile selection

On the main screen (“ODO” function selected), press the Adjustment Button 3 seconds to change the speed unit from km to miles.

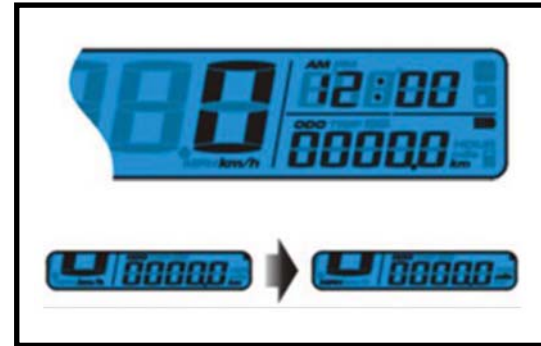

Using TRIP (partial route)

Adjustment Button once to change the “ODO” function (odometer) to “TRIP A.”

Press and hold the Adjustment Button for 3 seconds to start “TRIP A.”

Press the Adjustment Button to change from “TRIP A” to “TRIP B.”

Press and hold the Adjustment Button for 3 seconds to start “TRIP B.”





Total time

Press the Adjustment Button change from "TRIP B" to total use time "HOUR" (this cannot be set to zero).

Partial times

Press the Adjustment Button to change from total use time "HOUR" to Partial time A "Hour A."

Press and hold the Adjustment Button for 3 seconds to start Partial Time A.

Press and hold the Adjustment Button to change from Partial Time A to Partial Time B.

Press and hold the Adjustment Button for 3 seconds to start Partial Time B.

Press the Adjustment Button to go back from Partial Time B to the main screen.

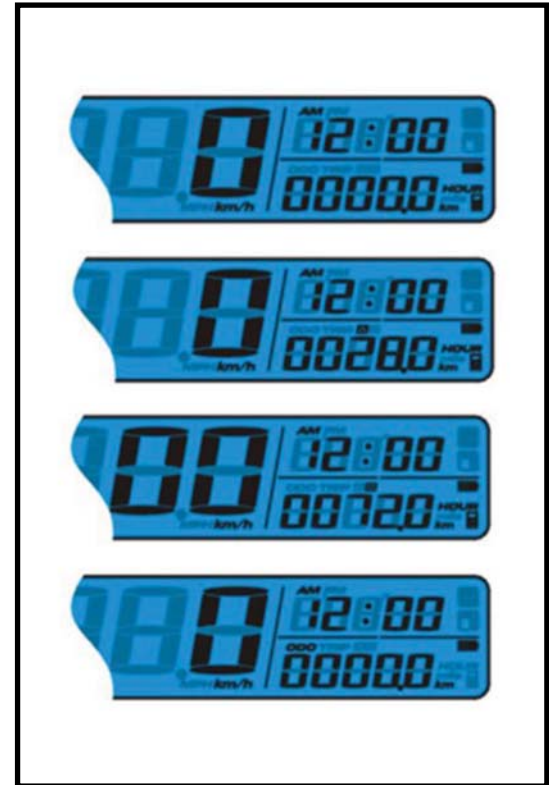



SELECTION BUTTON

Using the stopwatch

Press the Selection Button on the main screen to change from Clock to Stopwatch.

Press and hold the Selection Button for 1 second to start the stopwatch.

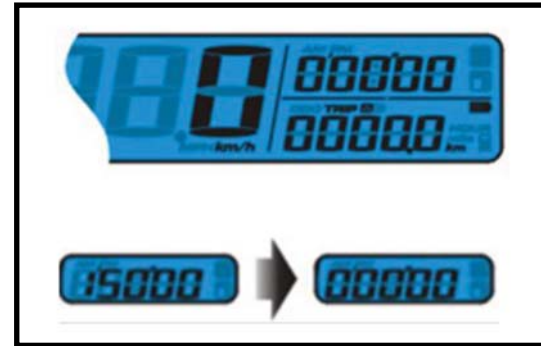

Speed log

The speed log tells us the maximum and average speed obtained. Press the Selection Button to change from Stopwatch to Speed Log.

Press and hold the Selection Button for 3 seconds to start the Speed Log. The Average Speed and Maximum Speed are shown on a 3-second rotation.

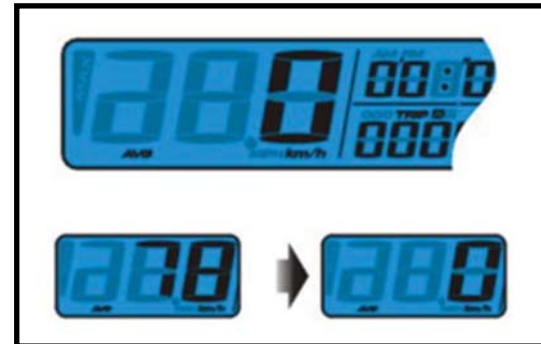



Press the Selection Button to go back from the Speed Log to the main screen.





Settings

To go to the settings menu on the main screen, press the Adjustment Button and Selection Button at once for 3 seconds.

Wheel diameter and number of pulses

On the "SPEED" screen, press the Adjustment Button to go to the sub-menu on tyre circumference.

Press the Adjustment Button to move the digit you wish to change and the Selection Button to change the numbers.

Once you have entered the tyre's circumference, press the Adjustment Button to go to the sub-menu on the number of pulses.

Press the Adjustment Button to move the digit you wish to change and the Selection Button to change the numbers.

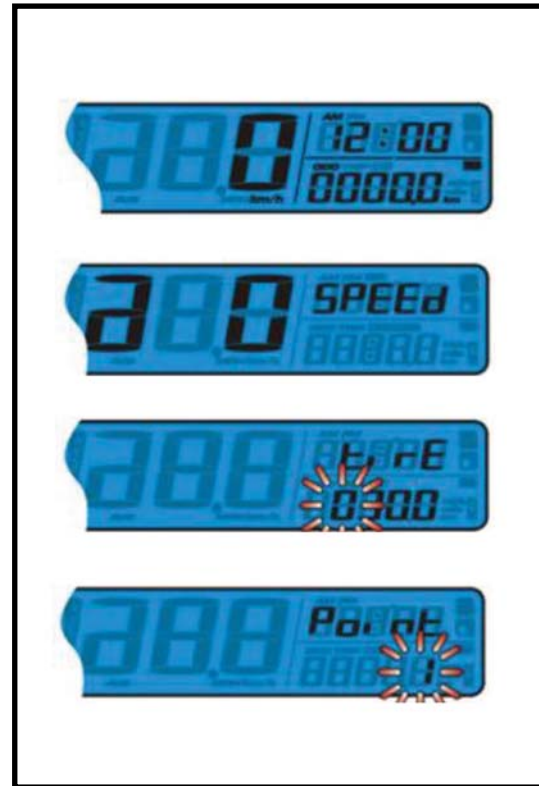



Wheel diameter and number of pulses

Wheel diameter and number of pulses numbers should be:

TYRE	DIAMETER	PULSES
ENDURO	2100	6
SUPERMOTARD	2030	6



CAUTION: If you enter numbers other than the ones provided, the speedometer will not show the correct speed. Rieju shall not be held liable for any consequence due to not entering the correct numbers.



ODOMETER “B”

Signals

Left blinker
Right blinker

Selection Button

Press the Selection Button on the main screen to change between clock mode, speed log, stopwatch, and maximum speed.

OBD indicator

Service icon is blinking when a failure on the OBD is detected.

Speedometer

Km/h or MPH units

Fuel light

Indicates if tank is in reserve

Temperature

Indicates excessive engine temperature

Time

Indicates time in 12-hour or 24-hour format

Signals

High beams

Adjustment button

Press the button to select the setting options

Signals

Neutral



Odometer

Viewing range: 0-9999 km (miles).
It automatically restarts after 99999 km (miles).
Viewing unit: 1 km (mile)

Partial odometer

Viewing range: 0-999.9 km (miles).
It automatically restarts after 999.9 km (miles).
Viewing unit: 0.1 km (mile)



Signals



“Neutral” gear light

This light lights up when the gear lever is in neutral.



Engine temperature light

This light is very important, because it tells us when the engine is too hot. This excess temperature may be due to several different factors.



CAUTION: You must not drive when this light is on since it can cause serious harm to the engine. Go as soon as possible to your RIEJU dealer.



Fuel light

The light turns on when the fuel level is below the reserve. Fill the tank as soon as possible to avoid running out of fuel.



“High beam” light

This light turns on when your vehicle’s “high beams” are on.



Blinker light

This light turns on when you have selected blinker lights (right or left).a).



OBD indicator

Service icon is blinking when a failure on the OBD is detected.



TOTAL (Odometer or ride time)

Cluster provides an odometer and ride time counter; both are displayed on LCD display. Regarding the ride time, it is obtained from internal crystal quartz. When the motorbike is turned on the ride time resumes counting time.

This option can be displayed scrolling by "MODE" button.

6 digits and "TOTAL" icon lighted.

Leading zeros suppressed.

Display range from 0 to 999999 km or miles or hours. If TOTAL is greater than 999999 units, it will be fixed as 999999 units.

Minimum display unit: 1 km or mile or hour.





Trip A / Trip B (Distance or ride time)

Cluster provides 2 trips and is displayed on LCD display.

This option can be displayed scrolling by “MODE” cluster button.

4 digits (3digits + decimal point + 1 digit), “TRIP” icon lighted and “A” or “B” on the left.

Leading zeros suppressed.

Display range from 0.0 to 999.9 km or miles or hours.

Trip A and B counter counts from 0 up to 999.9 (621.3 mi) and then rolls over to 0 and continue counting.

Minimum display unit: 0.1 km or miles or hours.

Trip A or B is reset by pressing “SET” button more





than 2 seconds when it is selected.

Trip A or B display the Trip A or B ride time pressing “SET” button less than 2 seconds.

Ride time is showed as an hour decimal number.
Examples: 30 min is 0.5 or 1 h 20 min is 1.3.



Clock

Cluster provides a clock and is displayed on LCD display.

Time is obtained from internal crystal quartz and is kept while cluster is connected to coin battery.



Clock format	If units of measure are km ⇒24h.
	If units of measure are mi ⇒12 h.
Clock precision	±2 s/day (25 °C)



Ride Time

Cluster provides a Ride Time and is displayed on LCD display.

Time is obtained from internal crystal quartz.

When the motorbike is turned ON the ride time resume counting.





Unit option selection (km or mi)

Cluster provides the possibility to change the units.

Pressing SET button with ODO or TOTAL TIME selected for more than 10 seconds, the current unit changes.





Wheel length display

Cluster provides the possibility to change the wheel length and be displayed.

To edit this value, with TOTAL ODO selected, the MODE button must be pressed during 10 seconds and the value is changed pressing Mode button lower value (2030 mm) is selected or Set button upper value is selected (2100 mm).

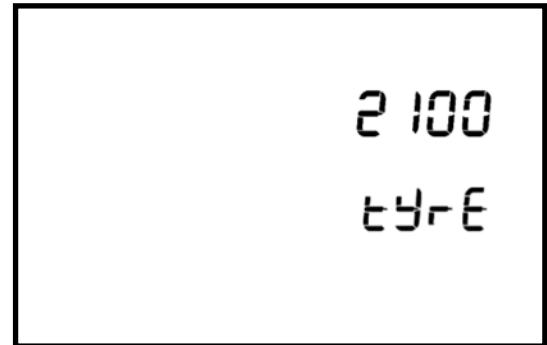
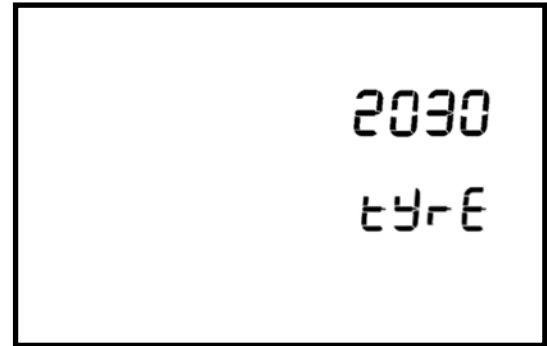



Pushing MODE and SET more than 2 seconds wheel length is saved. "Saved" will be displayed during 1 second on cluster.

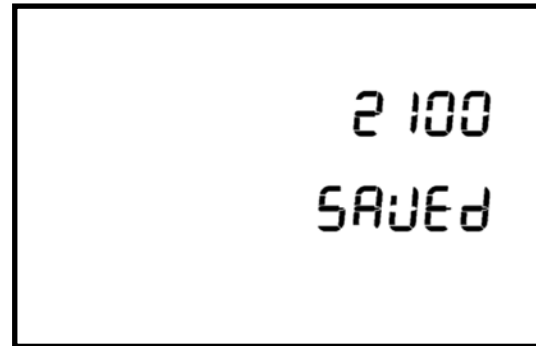

Fuel level

Fuel indicator is OFF if the fuel tank level is not in reserve level.

Fuel indicator icon is blinking when fuel tank level enters in the reserve level.





Coolant high temperature

Coolant high temperature icon is blinking when high temperature is detected.

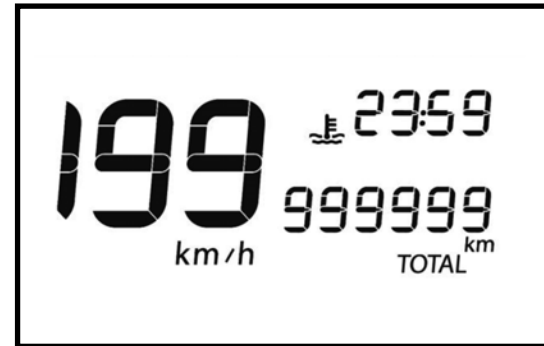

OBD indicator

Service icon is blinking when a failure on the OBD is detected.





FRONT SUSPENSION

The front suspension consists of a hydraulic fork that boasts the most cutting-edge technological and design resources.

Fork	Hydraulic with 37 mm bars
Amount of oil	310 c.c. per bar
Oil type	GRO SAE 15W



REAR SUSPENSION

Rear suspension is a hydraulic mechanical shock absorber that provides gentle operation.





REAR BRAKE PEDAL

The rear brake pedal is on the right side of the motorcycle. To activate it, press down with your foot.



Press the pedal gently to keep the back wheel from locking and skidding.



GEARSHIFT PEDAL

This is located under the left part of the motorcycle. Activate it with your foot, pushing it all the way. Allow it to return to its resting position before shifting gears again. To shift into first, push the pedal downward. To shift into other gears, raise the lever up with the tip of your foot.





KICKSTAND

The kickstand is on the left side of the vehicle.

To open it, keep the vehicle in vertical position and use your foot until it has gone all the way down.



CAUTION: Do not release the vehicle until you have verified that it is entirely stable.

To retract it, hold the vehicle by the handlebar. Next, place your foot on the back and place the vehicle in vertical position so that the kickstand returns to its retracted position.



Regularly check the condition and state of cleanliness of the springs. If they are dirty or worn, they can cause the kickstand to retract incorrectly.





FUEL TANK

To access the tank cap, please proceed as follows:

1- Insert the key into the lock and turn it 1/2 rotation to the left.

The cap has a spring to make opening easier.

2- Open the lid to access the tank cap.

3- Turn the tank cap anticlockwise until released from the tank.



CAUTION: Petrol is extremely flammable. When handling petrol, ensure that there are no sparks or flames in the area, and that it is completely ventilated.

TANK CAPACITY

6 litres



TYRES

The tyre pressure has a direct influence on the stability and comfort of the vehicle, on braking distance, and especially on user safety. As such, you must check tyre pressure.



TIP: Check that the wheel is not off-centre, and also check for wear on the tyre. Do not overload the vehicle since, in addition to losing stability, this increases tyre wear.



CAUTION: When pressure is very high or incorrect, the tyres stop absorbing shock. They transfer shaking and blows directly to the chassis and the handlebar, negatively affecting safety and comfort while driving.



TYRE	FRONT	REAR
ENDURO	1,7 Kg/cm ²	1,8 Kg/cm ²
SUPERMOTARD	2,2 Kg/cm ²	2,4 Kg/cm ²



BATTERY

To access the battery, you must remove the seat and the air filter cover.

Check that the terminals are clean and properly secured.

The battery does not require maintenance, so when it runs out, it must be replaced by a new one.

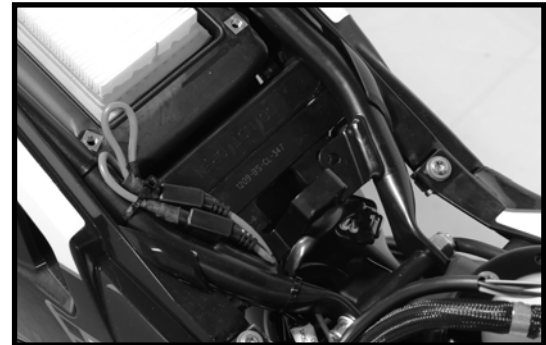
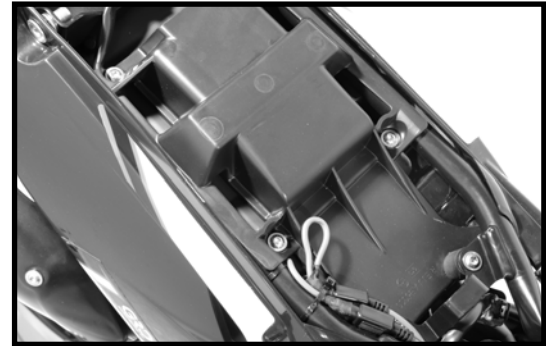

BATTERY TYPE

12V / 6Ah (maintenance-free)



DRIVING

Checklist before driving.

COMPONENT	CHECK	IF NECESSARY...
Accelerator grip	Play	
Tyres	Pressure, condition, and wear	Inflate or replace
Battery	Charge	Charge
Steering	Smooth steering, flexible movement, no slack	
Front headlight	Lighting	Replace
Brake light	Lighting	Replace
Position signals	Lighting	Replace
Instrument panel	Lighting	Replace
Brake discs	That they are not damaged and are completely clean	Replace
Brakes	Lever play Brake fluid level	Adjust Fill



CAUTION: The before-driving checklist must be completed each time the vehicle is used. If you see anything wrong, it must be repaired before using the vehicle.



Starting up the engine

1- Check that the engine is in neutral and completely close the accelerator grip.



2- Turn the key right to position .





3- Activate the start-up button.

4- Next, push the clutch lever and shift to first.

5- Progressively release the clutch lever as you gently accelerate.



TIP: Do not accelerate all the way or make the engine turn over too fast until it is warmed up enough.



CAUTION: Remember that you must not leave the engine running in a closed area, because the toxic gases from the exhaust may cause serious consequences to health.





Acceleration

Adjust speed by opening or closing the accelerator.

Turn the grip back to increase speed and turn it forward to decrease speed.

Braking

Close the gas grip and activate the front and rear brakes at once by progressively increasing pressure.



CAUTION: Abrupt braking can cause skidding and bouncing.

Stopping

Close the gas grip and activate both brakes simultaneously. When the vehicle has reduced its speed, press the clutch lever all the way down.

To stop the engine, remove the key from the ignition.

Once the engine is stopped, always close the fuel tap.



Driving

The most important period in the life cycle of your motorcycle is between kilometre 0 and 500. For this reason, we ask that you please carefully read the following instructions.

During the first 1,000 km, do not overload the motorcycle since the motorcycle is new and the different parts of the engine wear down and smooth against each other until reaching a state of perfect operation.

During this period, please avoid prolonged use of the engine at high revolutions or under conditions that could lead to overheating.



CAUTION: As stated in your Service Manual, you must go to the Official Rieju Shop for your first inspection after 1,000 km. This is essential. It is vitally important to make the appointments with the shop as indicated on the inspection slips and request the Shop's signature and stamp when you pick up the vehicle.

“Failure to comply” with these instructions is immediate grounds for loss of your Vehicle Warranty.



MAINTENANCE

Transmission chain (adjustment and tension)

The chain must be adjusted to have 30 to 40 mm tolerance at the midpoint between the output gear and rear pinion.

To adjust the proper tension, you must conduct these steps on both and equal sides of the wheel:

- 1- Put the gearshift box in neutral and loosen the nut and axle (1) of the rear wheel.
- 2- Loosen the fastening nut (3)
- 3- With the screws (2), adjust the chain's tension, making sure that there is always the same distance on both sides of the axle. To this end, use the ruler marks (4) on the swingarm.
- 4- Secure the position with the 2 nuts (3) and tighten the nut that holds the rear wheel axle.



TIP: The chain must be kept perfectly clean and adequately lubricate every week.

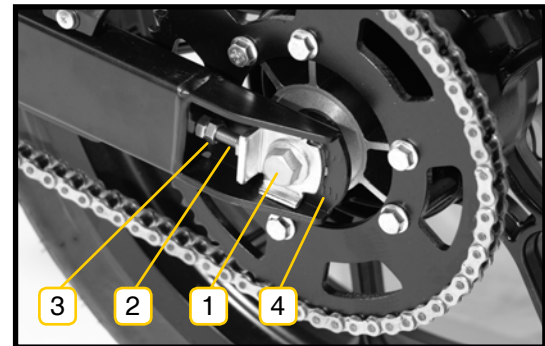



Front headlight bulb

To access the lamp holder and to change the bulb, please conduct the following steps:

- 1- Remove the two screws from the headlight (1), one on each side.
- 2- Tilt the headlight forward.
- 3- Disconnect the lamp (2).
- 4- Remove the protective rubber (3).

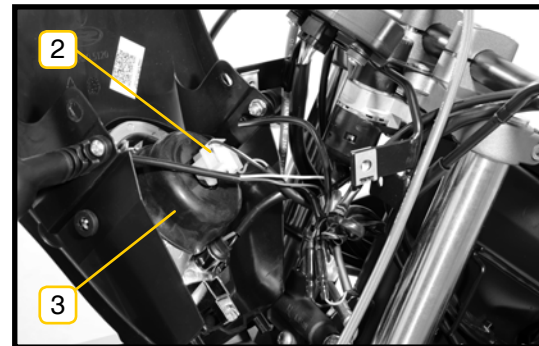
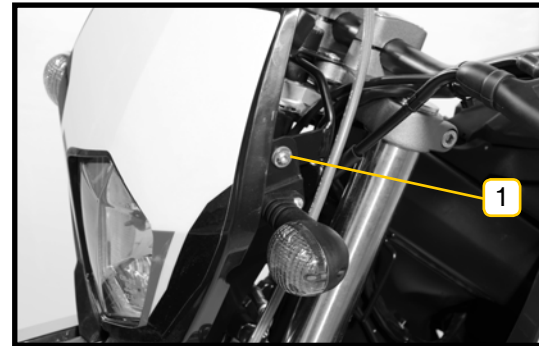



5- Remove the fixation clip (4).

6- Remove the lamp (5) and replace it.

BULB TYPE

12V HS1 35/35W



CAUTION: Using another kind of bulb may cause optic damage. If this happens, they will be excluded from the warranty.

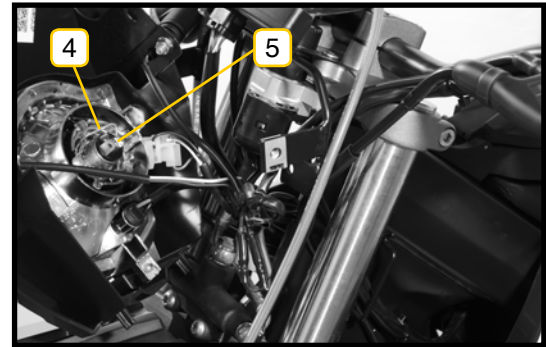



Position lamp bulb

To access the lamp holder and to change the bulb:

- 1- Conduct step 1 from the previous section.
- 2- Pull the lamp holder and remove the bulb.

BULB TYPE

5W



CAUTION: Using another kind of bulb may cause optic damage. If this happens, they will be excluded from the warranty.

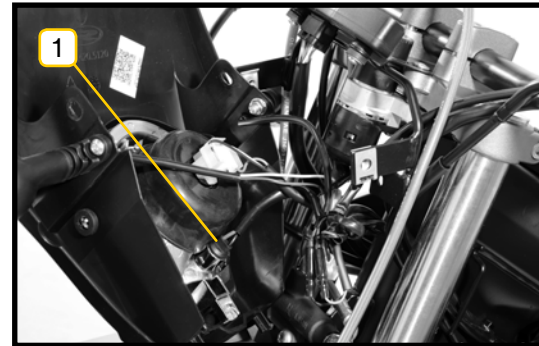

Rear light

Changing the rear light requires disassembling parts of the vehicle.



CAUTION: To guarantee proper installation, please see your Rieju distributor.





Plate light

Changing the plate light requires disassembling parts of the vehicle.



CAUTION: To guarantee proper installation, please see your Rieju distributor.





Brakes

The brake fluid tanks, one for each brake, have a viewer so you can check their level.



CAUTION: If the brake fluid level is nearing half in the viewer, both the front and the back brake, check brake pad thickness and check that they have not reached their limit for use. If the thickness is correct, fill the brake fluid and check that there are no leaks. If you are unsure, immediately go to your official **Rieju** dealer. They know what to do in all cases. This may affect your safety.

If the pedal or brake lever is spongy when activated, there may be air in the pump or circuit for each brake, or a component of the braking system may be in poor condition.

Do not mix different kinds of brake fluid.

The fluid used to fill or renew your circuit must meet the standard specified on each circuit's fluid tank. As such, DOT4 must be used with the rear brake.

The specification must never be changed; always follow the DOT4 specification. It is not important if the brake fluid is a different brand, but it is **NECESSARY** that it be the same specification.

Do not use fluid from a container that is unsealed (opened). **NEVER**, under any circumstances, use brake fluid from an unsealed container nor, obviously, brake fluid that has already been used.



Front brake - adjusting lever distance

To adjust the position, please follow the steps below:

- 1- Loosen the fastening nut (1).
- 2- Move the axle to adjust (2).
- 3- Set the position with the nut (1).

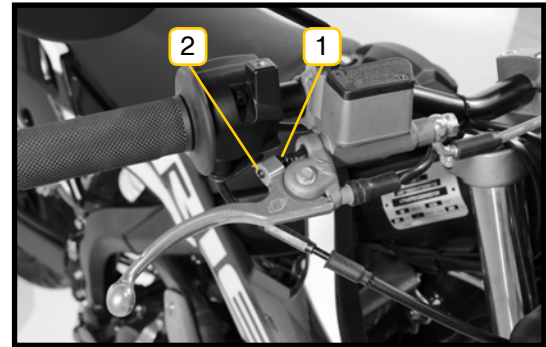

Rear brake - adjusting pedal distance

When the brake pedal is in resting position, it should have 5-7 mm play.

To adjust the position, please follow the steps below:

- 1- Loosen the fastening nut (1).
- 2- Move the axle to adjust the pedal (2).
- 3- Check that the brake responds correctly and does not create friction.
- 4- Set the position with the nut (1).





Front brake fluid level

Inspect brake fluid with the tank viewer (1) and change it periodically. It must also be changed if it appears contaminated with water or is dirty.

Brake fluid tanks must be at least half full.

If fluid is missing, it must be added. To this end:

- 1- Loosen the cover's screws (2).
- 2- Remove the cover with the bellows.
- 3- Fill the tank with fluid (3).
- 4- Put the lid on the tank.

RECOMMENDED FLUID

GRO DOT4



CAUTION: Brake fluid is corrosive and damages paint. If spilled, rinse immediately with water.

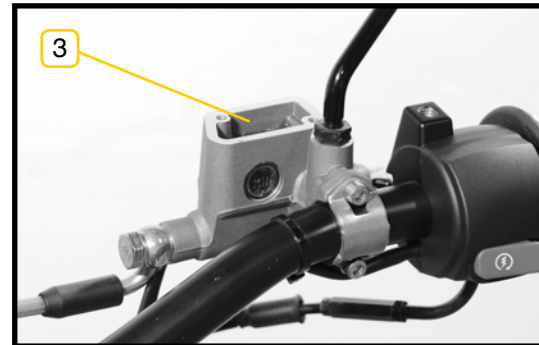
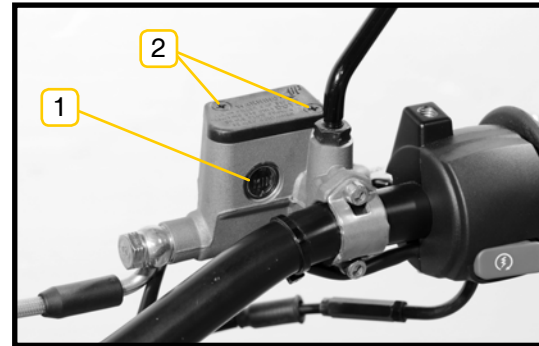



Rear brake fluid level

Inspect brake fluid with the tank and change it periodically. It must also be changed if it appears contaminated with water or is dirty.

Brake fluid tanks must be at least half full.

If fluid is missing, it must be added. To this end:

- 1- Remove the saddle and the right-hand side covers.
- 2- Next, remove the cover with the bellows (1).
- 3- Fill the tank with fluid (2).
- 4- Put the lid on the tank.

RECOMMENDED FLUID

GRO DOT4



CAUTION: Brake fluid is corrosive and damages paint. If spilled, rinse immediately with water.

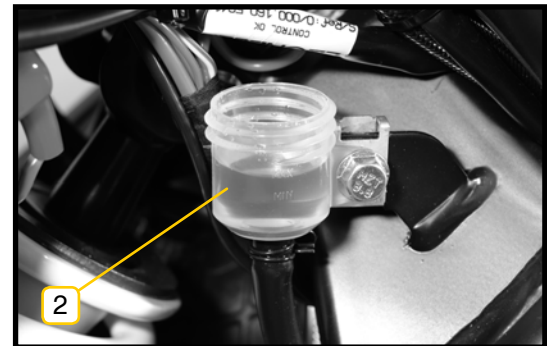
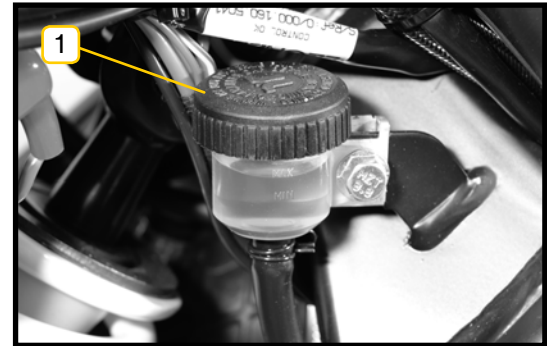



Clutch - Adjustment

To properly adjust the clutch, please follow the steps below:

- 1- Remove the protective rubber (1).
- 2- Loosen the fixation wheel (2).
- 3- Move the wheel to adjust the clutch (3).
- 4- With the wheel, set the position (2).
- 5- Place the protective rubber (1).

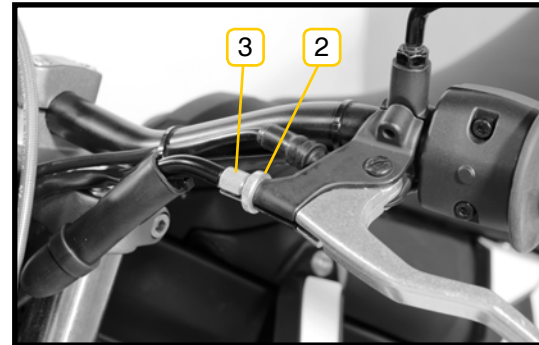
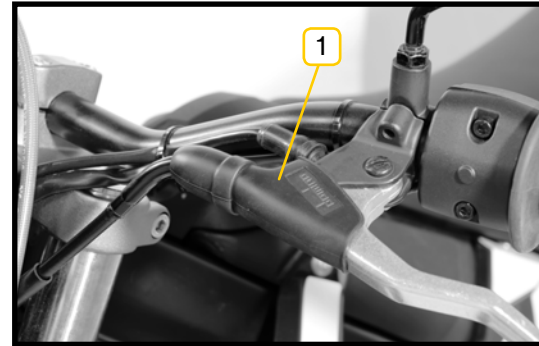



Fuel line - Adjustment

To properly adjust the fuel, please follow the steps below:

- 1- Remove the protective rubber (1).
- 2- Loosen the fixation wheel (2).
- 3- Adjust the grip's play (3) with the adjustment nut (4).
- 4- Set the position with the fixation nut (2).
- 5- Place the protective rubber (1).

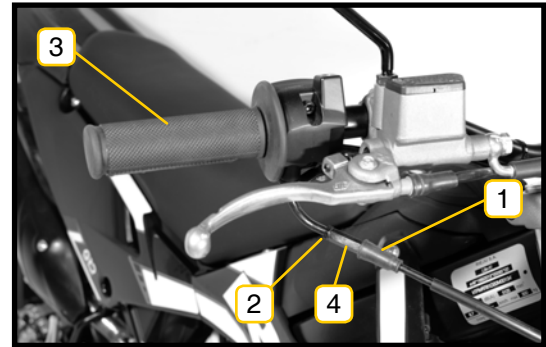

FUEL GRIP PLAY

2-3mm.



Brake pads

Brake pads are a very important element in the vehicle, so they require an inspection that you may conduct visually.



CAUTION: Changing pads requires mechanical knowledge to guarantee proper assembly.

To guarantee proper installation, please see your Rieju distributor.

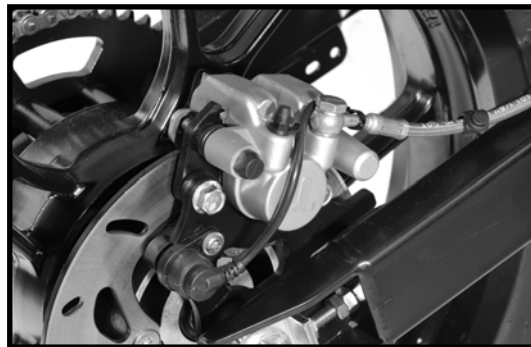

MINIMUM PAD THICKNESS

2 mm



Cooling system

The radiator, with great cooling power thanks to forced ventilation with an electro-fan that activates if necessary, is on the right side of the front of the motorcycle, behind the protective grille.



TIP: Check that the radiator is entirely full because this means that you can be sure that the coolant fluid is travelling the entire circuit. To verify the fluid level, lift the radiator's cover, while the vehicle is cold, and replace if necessary.



CAUTION: Never open the radiator's cover when the engine is hot. The boiling liquid can be released under pressure, which is dangerous. Use closed-circuit antifreeze. Using any other fluid may damage the elements in the radiator or the cooling circuit. This type of breakdown is not covered under the vehicle warranty.



COOLANT TYPE

GRO



Spark plug

The spark plug is an important component in the engine and is easy to inspect.

Periodically remove and inspect the spark plug because heating and soot deposits slowly deteriorate it. If the electrode is excessively eroded, or if there is too much soot or other deposits, replace the spark plug with another of the recommended type and thermal grade.



TIP: Before assembling any spark plug, measure the separation between electrodes with a feeler gauge and adjust according to specifications.



CAUTION: When installing the spark plug, always clean the surface of the washer housing to prevent debris from entering the combustion chamber. Screw the spark plug in by hand, gently along the threads, and finish by tightening with a suitable wrench.

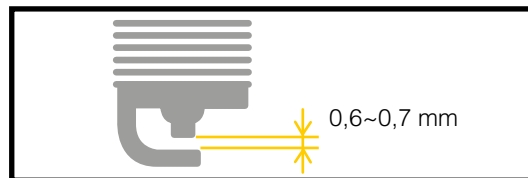

SPARK PLUG TYPE

CPR8EA

SEPARATION BETWEEN ELECTRODES

0,6~0,7 mm



Crankcase oil - checking and filling

Check the vehicle's oil as follows:

- 1- With the engine cold, position the vehicle horizontally.
- 2- Remove the oil filler cap (1) located on the clutch cover on the right of the engine.
- 3- Check the oil level with the rod (1) built into the oil filler cap.

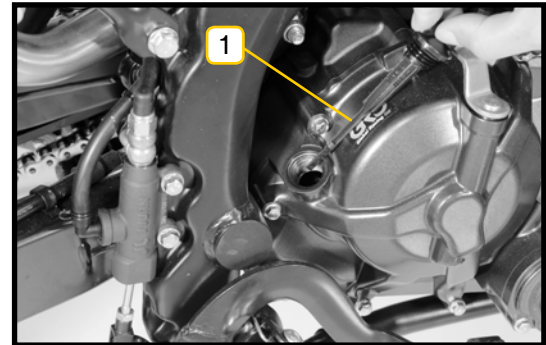
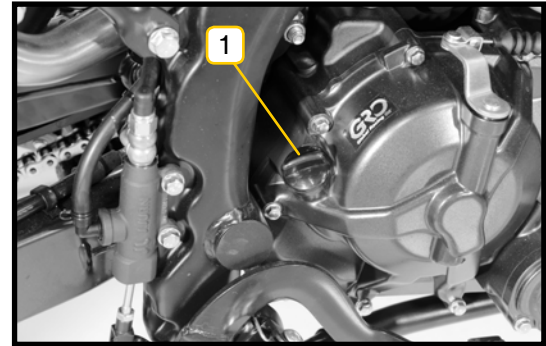



Optimum oil level is at the top of the rod (2) as a maximum point.

The minimum level of oil is position (3).

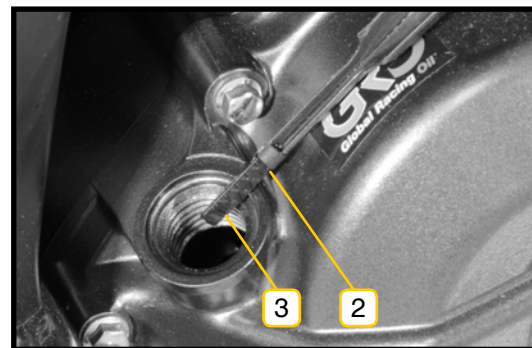

CAUTION: Driving the vehicle with the minimum level of oil in the crankcase (a) can lead to a serious engine issue. Breakdowns for this reason are not covered by the warranty.



CAUTION: Totally changing the oil requires mechanical knowledge. Rieju recommends that you go to your dealer to guarantee this operation.

OIL TYPE
GRO 10W40



Air filter

The proper operation and durability of engine components like the connecting rods, piston, segments, cranks-haft bearings, and even the cylinder, largely depend on the air filter being clean and greased.

To access the air filter:

1- Remove the two screws (1), one on each side, to disassemble the motorcycle seat, providing free access to the filter box.

2- Remove screws (A).

3- Remove the screw and silentblok (B) and remove the cover.

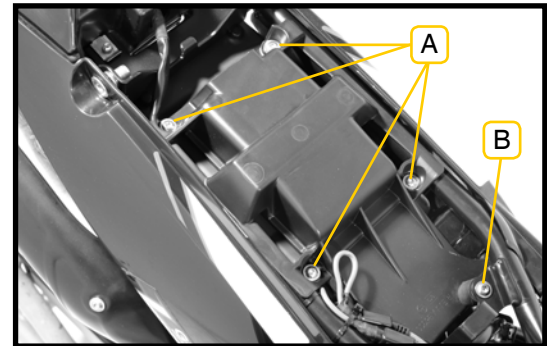
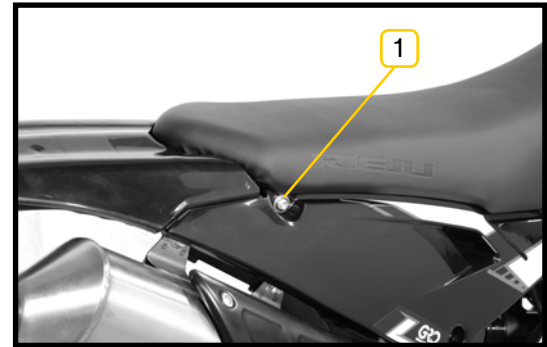



4- Remove the air filter (C) and replace it.



TIP: This must be replaced more frequently if the vehicle is used in dusty or humid areas.

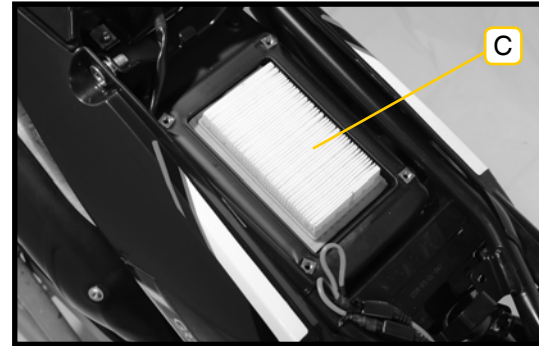

CAUTION: Not periodically checking this component and cleaning it can lead to improper engine operation, as well as important breakdowns that would not be considered factory defects.



Steering play

Steering must always be adjusted so that the handlebar turns freely, but without play.

To check steering adjustment, lift the motorcycle from the ground, using a stand under the chassis.

Move the handlebar gently in each direction. If, when you release the handlebar, it continues moving on its own, this means that the steering is not too tight.

Crouch in front of the motorcycle, grab the lowest part of the front fork (on the axle) and stretch the fork.

If there is play, steering is too loose.



CAUTION: Adjusting steering requires mechanical knowledge. Rieju recommends that you go to your dealer to guarantee this operation.



General lubrication

For your vehicle's lifespan to be long, we recommend keeping several elements lubricated:

- Clutch lever.
- Front brake lever.
- Rear brake pedal.
- Rear brake pedal bushing.
- Shift lever (5).
- Fuel line.
- Transmission chain.

This is necessary after driving on wet ground and when the chain looks dry.

This chain is roller, so a specific lubricant should be used for this type of chain.



Maintenance table

COMPONENT	1.000 Km	4.000 Km	7.000 Km	10.000 Km	+3.000 Km
Air filter	L/E	C	L/E	C	L/E - C
Engine oil	C	C	C	C	C
Oil filter	C	C	C	C	C
Centrifuge oil filter (Tango)				I	
Check oil pump operation	I	I	I	I	I
Check transmission leaks	I	I	I	I	I
Check crankcase leaks	I	I	I	I	I
Cylinder head, cylinder, and piston			I		
Timing chain / Running time			I		
Valve adjustment	I		I		I (+6.000 Km)
Segment wear check			I	I	
Clutch			I	I	
Spark plug	I	I	I	C	I - C (+10.000 Km)
Transmission chain tension and wear	I/E	I/E	I/E	C	I/E - C (+10.000 Km)
Battery	I	I	I	C	I - C (+10.000 Km)
Electrical system	I	I	I	I	I
Inspect and adjust carburettor	I		I		I (+6.000 Km)



Carburettor (idle)	I		I		I (+6.000 Km)
Fuel line	I	I	I	I	I
Exhaust system	I	I	I	I	I
Controls, accelerator, and cable operation	I	I	I	I	I
Steering and handlebar	I	I	I	I	I
Shock absorbers	I		I		I
Front/rear suspension	I		I		I
Central kickstand/stand	I		I/E		I/E
Brake mechanism / Covering	I	I	I	I	I
Coolant and level	I	I	I	C	I - C (+10.000 Km)
Brake fluid	I	I	I	C	I - C (+10.000 Km)
Brake pads	I	C	C	C	C
Brake disc	I	I	C	I	I - C (+7.000 Km)
Check wheel spoke tension and off-centre	I	I	I	I	I
Tyres: pressure and condition	I	I	I	C	I - C (+10.000 Km)
Engine screws and nuts	I	I	I	I	I
Screws/nuts for each component	I	I	I	I	I



The maintenance schedule may change depending on motorcycle use, driving, environmental conditions, etc...

I: check-adjust / C: change
E: grease / L: clean



CLEANING AND LONG-TERM STORAGE

Cleaning

Cleaning the motorcycle will improve its performance and lengthen the lifespan of the motorcycle's components. Operations before cleaning:

- 1- Cover the exhaust pipe input to prevent water from entering its interior.
- 2- Ensure that the spark plug and different caps are properly placed.
- 3- If the engine is very dirty, apply de-greaser.



CAUTION: Do not apply de-greaser to the wheel axles or the chain.

- 4- Remove the de-greaser and dirt with pressurised water.
- 5- Clean all surfaces with warm water and gentle detergent.
- 6- Remove the soap with cold water, then dry all surfaces.
- 7- After all cleaning is complete, run the engine for a few minutes on idle.



CAUTION: Rieju shall not be held liable for using corrosive de-greaser elements that stain or deteriorate motorcycle elements. Rieju shall not be held liable for possible damages and defects caused by using pressurised water to clean the motorcycle.



Long-term storage

For long-term motorcycle storage, we advise cleaning the motorcycle beforehand as explained above.

- 1- Empty the fuel tank, pipes, and the carburettor float chamber.
- 2- Lubricate all control cables.
- 3- Cover the exhaust pipe so that moisture cannot enter.
- 4- Remove the battery and charge it once per month.



WARRANTY

Standards regulating manufacturer RIEJU'S warranty.

The company RIEJU hereby guarantees the end consumer, purchaser of a vehicle manufactured by RIEJU, that both the materials and the manufacturing are free from defect, pursuant to the highest quality standards. Consequently, RIEJU hereby provides the end purchaser (hereinafter, the "purchaser"), pursuant to the conditions set forth below, with a warranty to repair all material or manufacturing defects found on a new motorcycle at no cost, within the established warranty period and with no limitation in terms of the number of kilometres travelled or the number of hours the vehicle has been operated.

Warranty Period

The warranty period shall be governed by warranty law in the vehicle's country of sale, in force at the time it is sold.



Warranty claims for defects not brought to the attention of a RIEJU-authorized dealer before the end of the warranty period shall be excluded.

Purchaser obligations

RIEJU may legitimately reject warranty claims if, and to the extent that:

- a) The purchaser has not brought the vehicle to any of the inspections and/or to undergo maintenance tasks as required in the user manual, or the date set for these inspections or maintenance tasks has passed. Also excluded from the warranty are defects that appear before the date established for an inspection or



maintenance task that never occurred, or that will occur after the established date.

- b) Inspections, maintenance work, or repairs have been conducted by third parties not recognised or authorised by RIEJU.
- c) Any maintenance or repair has been conducted in violation of the technical requirements, specifications, and instructions set forth by the manufacturer.
- d) Replacement parts not authorised for use by RIEJU have been used in maintenance or repair work on the vehicle, or if, and to the extent that, fuels, lubricants, or other liquids (including, but not limited to, cleaning products) that were not expressly mentioned in the User Manual's instructions have been used on or in the vehicle.
- e) The vehicle has been, in any way, altered or modified or fitted with components other than the components expressly authorised by RIEJU as components allowed for the vehicle.
- f) The vehicle has been stored or transported in a way that is contrary to technical requirements.
- g) The vehicle has been used for a special use other than ordinary use, such as competition, racing, or in an attempt to beat a record.
- h) The vehicle has suffered a fall or accident that directly or indirectly causes damages.

Warranty exclusions

The following articles are excluded from the warranty:

- a) Replacements for wear, including, but not limited to, spark plugs, batteries, fuel filters, oil filter elements, chains (secondary), engine output pinions, rear rings, air filters, brake discs, brake pads, clutch disks, bulbs, fuses, carbon brushes, footrest rubber, tyres, chambers, wires, and other rubber components, ex-



haust pipe, and washers.

- b) Lubricants (for example, oil, grease, etc.) and operational fluids (for example, battery fluid, coolant, etc.).
- c) Inspection, adjustment, and other maintenance work, as well as all kinds of cleaning work.
- d) Damage to the paint and consequent rust due to external influences, such as rocks, salt, industrial fumes, and other environmental impacts, or inadequate cleaning with inadequate products.
- e) Damages caused by defects, as well as expenses caused directly or indirectly by the defects (for example, communications expenses, lodging expenses, car hire expenses, public transport expenses, recovery vehicle expenses, emergency messenger expenses, etc.) as well as other financial harm (for example, caused by loss of use of a vehicle, lost income, lost time, etc.).
- f) Acoustic or aesthetic circumstances that do not significantly affect conditions for use of the motorcycle (for example, small or hidden imperfections, normal noise or vibration in use, etc.).
- g) Circumstances due to vehicle ageing (for example, fading of painted surfaces or metal coating).

Miscellaneous

- a) If repair of the defect or replacing the part is disproportionate, RIEJU shall be entitled to decide, at its sole discretion, whether to repair or replace the defective parts. Ownership over the replaced parts, if applicable, shall be held by RIEJU, with no other consideration. The dealer authorised by RIEJU whom has been entrusted to repair defects shall not be authorised to make binding statements on RIEJU'S behalf.
- b) If there is doubt as to whether there is a defect or a visual or material inspection is required, RIEJU reserves the right to require that the parts being claimed under the warranty be sent to it, or to request that a RIEJU



expert examine them. Any additional warranty obligations for replaced parts at no cost or for any services provided at no cost under this warranty shall be excluded. The warranty for replaced components during the warranty period shall end on the expiry date of the warranty period of the respective product.

c) If a defect cannot be repaired and its replacement is disproportionate for the manufacturer, the consumer under warranty shall be entitled to cancellation of the contract (payment of a compensation) or partial reimbursement of the purchase price (discount) instead of motorcycle repair.

d) The purchaser's warranty claims under the purchase-sale contract with the authorised dealer shall not be affected by this warranty. This warranty shall not affect the purchaser's additional contractual rights under the general business conditions of the authorised dealer. However, said additional rights may only be claimed with the authorised dealer.

e) If the purchaser resells the product during the warranty period, the terms and conditions of this warranty shall continue to exist under their current scope, such that rights to claim pursuant to this warranty under the terms and conditions governed by this document shall be transferred to the new owner of the motorcycle.



RIEJU

FOR EVERYDAY ADVENTURE