



MX



OWNER'S MANUAL
MANUEL DU PROPRIÉTAIRE
MANUAL DEL PROPIETARIO



RIEJU S.A. is grateful for the confidence you have put in their company and would like to congratulate you on your choice of motorbike.

The **MX** are the resulted of the long-term experience that **RIEJU** has had in competitions, which has led to the development of a high performance vehicle.

The objective of this owner's manual is to denote the use and maintenance of your vehicle, we ask you to read the instructions and information that follow carefully.

We wish to remind you that the life of the vehicle depends on how it is maintained. Maintaining the vehicle in perfect working condition reduces the cost of repair.

This manual has to be considered as an integrate component of the motorbike and must remain part of the basic equipment, and handed over in the event of a change of vehicle ownership.

In the event of any problems, please consult the RIEJU dealer who will assist you or check our web www.riejumoto.com.

Please remember that for your motorbike to perform correctly, **you should always fit original spare parts.**



The illustrations are for demonstration purposes only. They may not reflect the exact appearance of the actual product. Specifications are subject to change. Please read and understand the entire manual before allowing children to use this product! Carefully read the instruction manual, thoroughly inspect all parts to ensure the child's riding safety, and contact the dealer immediately if any issues are found.



WARNING : READ THE FOLLOWING SAFETY INSTRUCTIONS CAREFULLY.

- Children should use the product under the supervision of parents or adults. Protective gear (such as helmets, gloves, knee pads, elbow pads, etc.) should be worn when riding. Note that this product is not intended for traffic use.
- Please comply with local laws or regulations; reduce speed and increase braking distance in rainy, snowy, or slippery areas to ensure safety.
- When you get off the bike or push it, turn off the bike to prevent it from accidentally starting while adjusting the speed, leading to unexpected incidents.
- Do not let hands, feet, body parts, clothes, or similar items come into contact with any rotating or moving parts (e.g., wheels, disc brakes, etc.).
- Riders should be cautious as it requires skill to avoid falling or colliding, causing injury to the user or third parties.
- Parents or guardians should ensure that children have received appropriate instructions on using the mini electric motorcycle, especially for the safe use of the braking system.
- Riding near rivers, on roads, in areas with heavy traffic, crowded places, or other potentially dangerous conditions is prohibited.
- This series is only suitable for children aged 3-8 years old to ride.



NOTES :

- The bike should be stored in a dry and ventilated place.
- Disassembly and replacement of parts by non-professionals are prohibited. The bike needs to be assembled and adjusted by adults, and children are not allowed to operate it.
- Before riding, check whether all parts and screws are tightened, tire pressure is normal, and brakes are functioning properly.
- The maximum load capacity of the mini electric motorcycle is 50Kg.
- Antes Only use the dedicated charger for charging the product.
- If the bike has power but cannot move, turn off the power immediately to avoid damaging the electronics.



CONTENTS

PACKAGING DETAILS	7	ROUTINE MAINTENANCE	16
COMPLETE ASSEMBLY	8	Electrical Component Maintenance	16
Rear Shock Absorber Installation	8	Brake Maintenance Instructions	16
Front Shock Absorber Installation	8	Mechanical Brake Maintenance	16
Front Mudguard Installation	9	Hydraulic Brake Maintenance	17
Front Wheel Installation	9	Transmission Maintenance Instructions	17
Front Disc Brake Installation	10	Suspension System Maintenance Instructions	17
Handlebar Installation	10	Tire Maintenance Instructions	18
Brake Installation	11	Whole Vehicle Appearance Maintenance	18
Brake Cable Installation	11	Common Fault Troubleshooting Instructions	18
Left and Right Brake Lever Installation	11	Throttle Troubleshooting	18
Fastener Inspection	12	Motor Troubleshooting	19
Handle Operation	12	Controller Troubleshooting	19
Power On/Off	12	CLEANING AND STORAGE	20
Speed Adjustment	13	Cleaning the vehicle	20
Battery Display	13	Store the vehicle for a long time	21
Charging Instructions	14	Short-term storage of the vehicle	22
USAGE SCENARIOS	15	WARRANTY	23
Usage Scenario Illustrations	15		



PACKAGING DETAILS

No.	Name	Quantity
1	Complete Vehicle	1
2	Tool Kit	1
3	Front Mudguard	1
4	Front Wheel	1
5	Attachments (Front Wheel Axle, Front Mudguard, Installation Screws, Rear Shock Absorber Installation Screws)	1
6	Charger	1

No.	Name	Quantity	Illustration
1	Tool Kit	1	
2	Front Mudguard	1	
3	Front Wheel	1	
4	Attachments	1	
5	Charger	1	



COMPLETE ASSEMBLY

Rear Shock Absorber Installation Diagram

Lift the rear of the bike. Align the lower end of the rear shock absorber with the mounting hole on the rear fork of the frame. Use a tool to tighten the rear shock absorber mounting bolt (10-12 Nm).

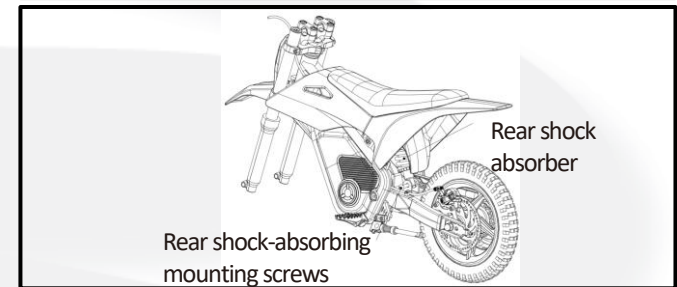
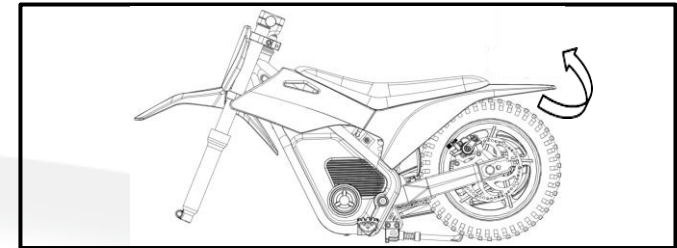

Front Shock Absorber Installation Diagram

Use a tool to loosen the four fastening screws as shown in the diagram. Press the front shock absorber down until it is flush with the upper connecting board. Tighten the four screws(11-13 Nm).

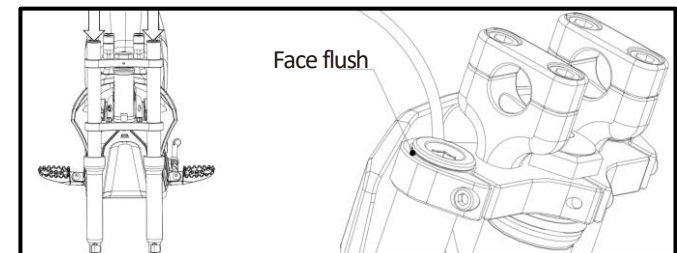
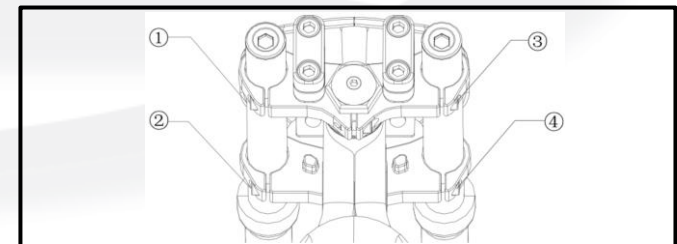



COMPLETE ASSEMBLY

Front Mudguard Installation Diagram

Align the front mudguard limiter buckle towards the back and attach it to the lower fork board. Insert the limiter post of the front mudguard into the inner limiter hole of the number plate. Use a tool to tighten the front mudguard screw into the lower fork board mounting hole (8-10 Nm).

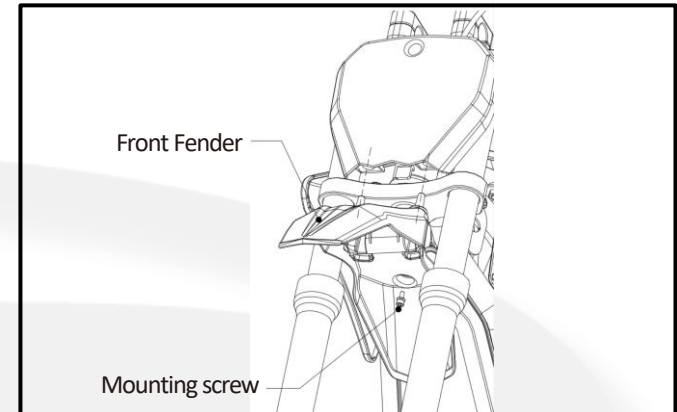

Front Wheel Installation Diagram

Place the front wheel in the middle of the front fork gap as shown in the diagram. Assemble as shown and use a tool to tighten the mounting nut onto the front wheel axle (25-30 Nm).

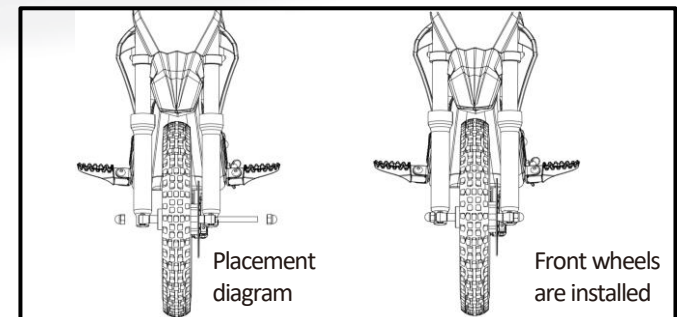
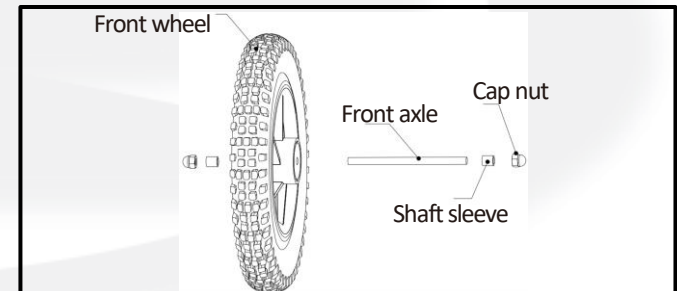



COMPLETE ASSEMBLY

Front Disc Brake Installation Diagram

Remove the disc brake mounting screw from position ①. Rotate the disc brake to position ② and align the center hole. The disc brake caliper should align with the disc on the front wheel. Use the mounting screws to tighten the disc brake (8-10 Nm).

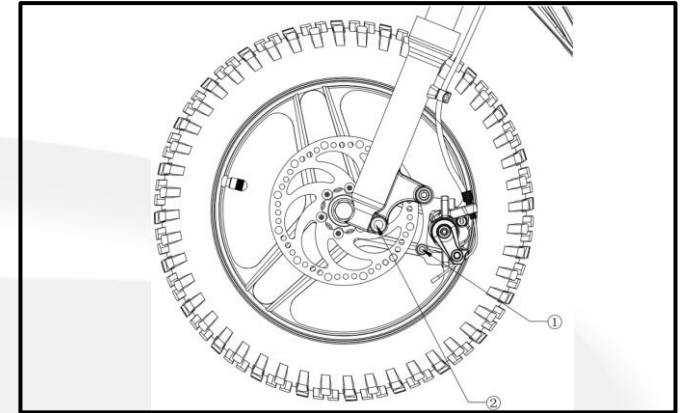

Handlebar Installation Diagram

Use a tool to remove the four screws from the handlebar stem. Install the handlebar as shown in the diagram. Adjust the handlebar angle to a comfortable position. Use a tool to tighten the four screws on the handlebar stem (10-12 Nm), ensuring the gap between the handlebar stem and the lower stem is even.

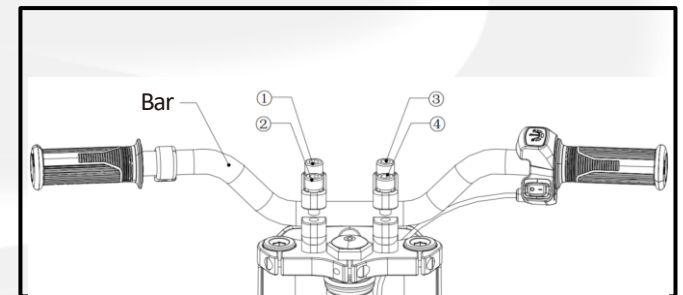



COMPLETE ASSEMBLY

Brake Installation Diagram

Brake Cable Installation

For model MX-12: Rotate the brake lever adjustment screw to align the opening with the cable outlet. Insert the brake cable head into the cable head seat of the brake lever. Pull the cable core into the brake lever outlet with a force. Finally, rotate the opening nut half a turn to misalign.

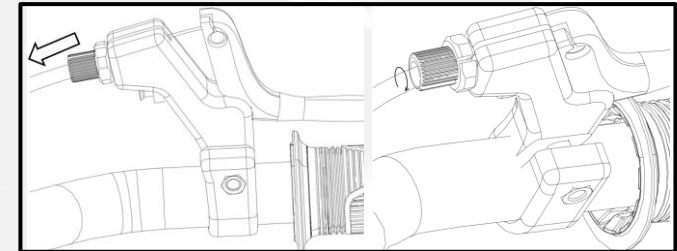
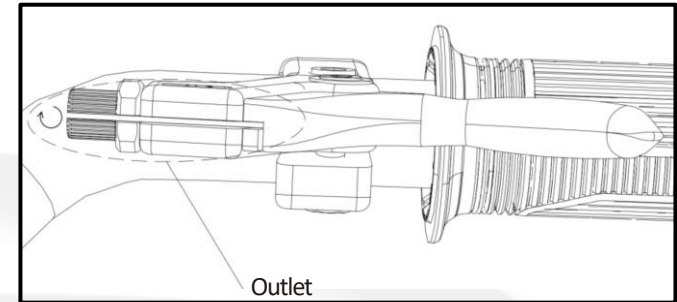

Left and Right Brake Lever Installation

For model MX-14: Use a tool to remove the brake lever fastening screws. Install the brake lever as shown in the diagram and pre-tighten. Move the left brake lever to 20-25 mm from the handlebar grip and adjust to a suitable angle. Use a tool to tighten screw ① (8-10 Nm). Move the right brake lever to 10-15 mm from the throttle grip and adjust to a suitable angle. Use a tool to tighten screw ② (8-10 Nm).

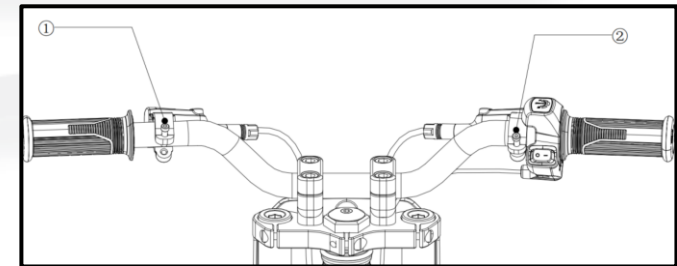



OPERATING INSTRUCTIONS

Fastener Inspection

Before using this vehicle, you should inspect all fasteners as shown in the diagrams to ensure they are not loose. This is essential to prevent any safety hazards due to loosened fasteners.

No.	Name	Torque Value
①	Front wheel nut	25-30 Nm
②	Bottom bracket nut	10-12 Nm
③	Rear shock bolt	10-12 Nm
④	Rear wheel nut	25-30 Nm

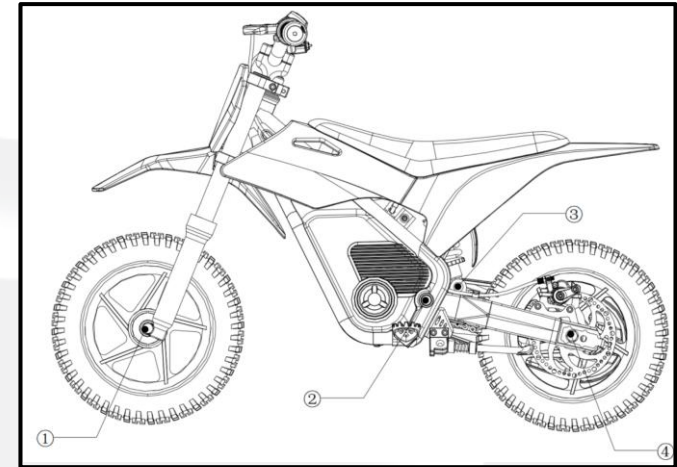

Handle Operation

Power On/Off

The diagram shows the vehicle's power button. To operate the vehicle, use this button to turn the power on or off. The "I" position indicates that the vehicle is on, and the "O" position indicates that it is off. When the display lights up, the vehicle is in the on state; when the display lights go off, the vehicle is in the off state.

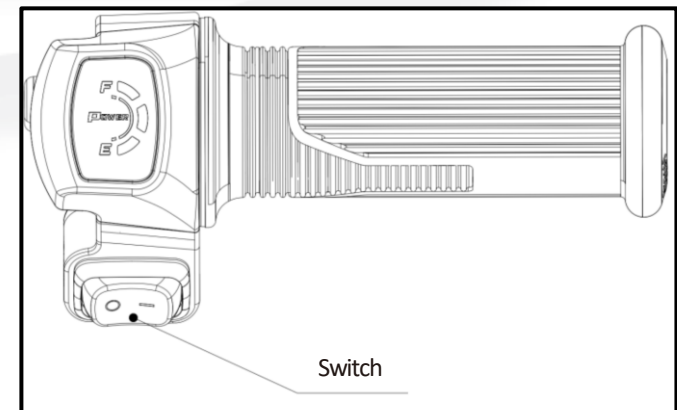



OPERATING INSTRUCTIONS

Speed Adjustment

This series of products has two gear adjustment methods, which can be used for second or third gear speed regulation. Figure 1 shows the second gear speed regulation button, the switch is pressed to the "I" position for first gear, and the switch is pressed to the "O" position for second gear. Figure 2 shows the three-speed control button. The switch is pressed to the "O" position for first gear, pressed to the "I" position for second gear, and pressed to the "=" position for third gear.

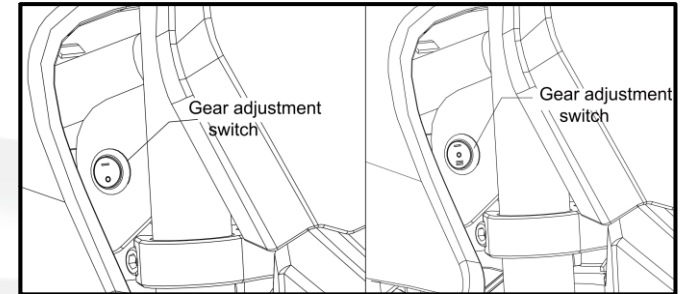
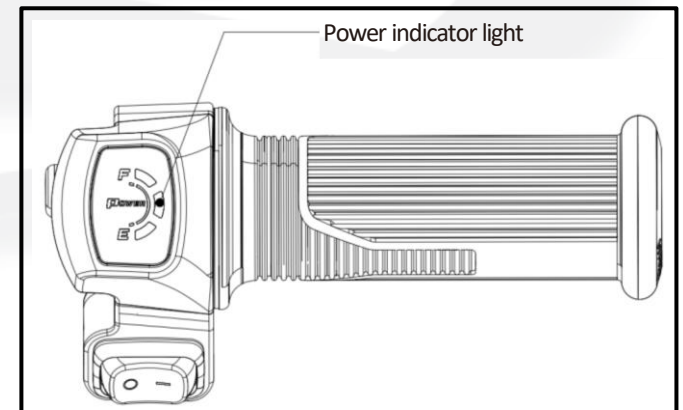

Figure 1

Figure 2

Battery Display

The diagram shows the battery display function. The meter has three lights; when all three are lit, the battery is over 75% charged. When only one light remains and it changes from green to red, it indicates that the vehicle needs to be charged to continue riding.





OPERATING INSTRUCTIONS

Charging Instructions

To charge this product, connect the charger to the input end, then plug the input end into a household socket, and insert the output end into the charging port shown in the diagram to start charging the vehicle.

The charging mode is indicated by the color of the light at the depicted location. A red light indicates that charging is in progress, and a green light signifies that the battery is fully charged. It is important to disconnect the charger once the battery is fully charged to avoid damaging the battery. Note that there is no voltage output from the vehicle when the battery is charging.

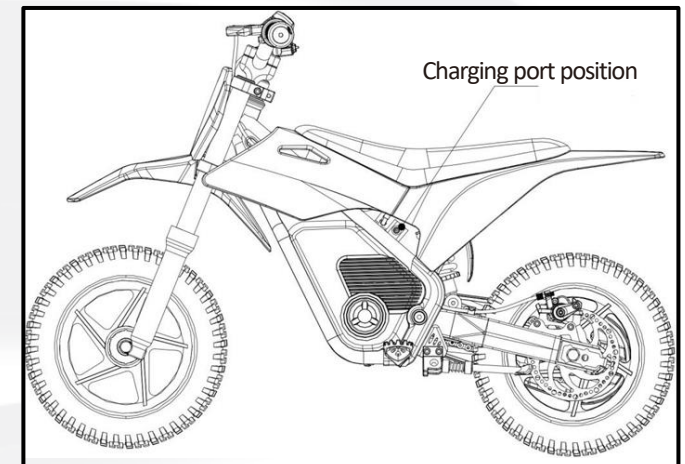
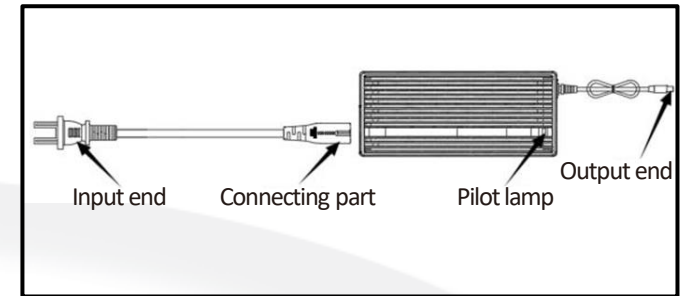



USAGE SCENARIOS

Usage Scenario Illustrations





ROUTINE MAINTENANCE

Electrical Component Maintenance Instructions

Lithium-ion batteries should be stored in a cool, dry, and ventilated environment, away from sources of fire and heat. The optimal storage temperature for batteries is 10-25°C, with the best humidity being 60±25%. Batteries should be stored at room temperature and charged to 20% to 40% of their capacity.



WARNING:

To prevent battery over-discharge, it is recommended to charge and discharge the battery once every 3 months according to the standard charging and discharging method, and then charge it to 20%~40% of its capacity according to the standard charging method.

Brake Maintenance Instructions

Mechanical Brake Maintenance Instructions

For vehicles with short usage time, Just fine-tune the adjusting nut on the brake to adjust the braking effect to the appropriate state;

For vehicles with longer usage time, check the wear condition of the brake pads. If the brake pads are slightly worn, use an M5 Allen wrench to loosen the disc brake cable fixing nut, shorten the disc brake travel, tighten the fixing nut with the M5 Allen wrench, and then adjust the braking effect to an appropriate state;

For vehicles with longer usage time and severe wear of the brake pads, it is necessary to replace the brake pads to continue riding. To replace the front and rear disc brake pads, first remove the caliper fixing screw, use pliers to remove the clip, remove the pin, directly remove the two brake pads along with the spring, take out the two brake pads and the spring clip, then start installing new brake pads, attach the same model brake pads to the spring, pinch the two brake pads together into the caliper, and follow the steps in reverse order to reinstall.



ROUTINE MAINTENANCE

Hydraulic Brake Maintenance Instructions

When maintaining the brake, use a special tool to unscrew the disc brake lever oil filling port screw, and then inject oil into the oil pipe with a syringe to adjust the braking effect to an appropriate state;

If the braking performance is still not ideal after oil injection, it is necessary to replace the disc brake pads to continue riding. Use an M5 Allen wrench to disassemble the front and rear disc brakes, remove the brake pads, then install the same model brake pads into the disc brake, reinstall the front and rear disc brakes with an M5 Allen wrench, adjust the disc brake to avoid friction with the disc brake rotor, and then normal riding is possible.



NOTE: Professional personnel should perform these operations.

Transmission Maintenance Instructions

When maintaining the transmission, the chain should be cleaned promptly after riding the whole vehicle and lubricated regularly with chain oil.

Suspension System Maintenance Instructions

When maintaining the suspension system, pay attention to whether there is mud and water inside the rear shock absorber and on the travel tube of the front fork, as mud and water can cause the rear and front shock absorbers to stick during use.

Clean and maintain regularly according to personal usage frequency to avoid a decrease in riding comfort.



NOTE: Professional personnel should perform these operations.



ROUTINE MAINTENANCE

Tire Maintenance Instructions

Measure whether the tire pressure meets the tire label pressure; if not, adjust the pressure by inflating or deflating. After supplementing the pressure, ensure to put on the valve cap.

Depending on the frequency of use, if the tire tread is severely worn, the tire needs to be replaced to continue riding.

Whole Vehicle Appearance Maintenance Instructions

After using the vehicle, first use a duster to remove surface dust, then wash with a water gun at low pressure, but was top to bottom and avoid important electrical parts such as the battery compartment, motor shaft, and controller, then dry the whole vehicle with a dry cloth and store in a dry, ventilated place.



WARNING :

Do not use pressure wash systems as this may damage both mechanical and electrical parts of the vehicle. Damage caused by the use of pressure washing systems will not be accepted under warranty.

Common Fault Troubleshooting Instructions

Throttle Troubleshooting

If the battery is normal and the display screen lights up, then there is no fault with the display; if the display does not light up, there may be a fault with the display or controller.



ROUTINE MAINTENANCE

Motor Troubleshooting

If there is not fault with the battery, display, or controller, and the motor operates normally when the throttle is turned, then motor is normal; if the motor does not turn, then is a fault with the motor.

Controller Troubleshooting

If there is not fault with the battery and the display, and the motor operates normally when the throttle is turned, then controller is normal; if the motor does not turn there may be a fault with the motor or controller.



NOTE: If any of the above faults occur, please contact the dealer for repair promptly.



CLEANING AND STORAGE

Cleaning the vehicle

Regular and proper cleaning of your vehicle will extend its life of service

Preparation

- Wait until the motor cools down.
- Close all covers and electrical connections to prevent from water.

Do not use gasoline, rust remover, brake disc cleaner, etc. to clean plastic parts and painted parts, as this will cause them to deteriorate and be damaged.

Clean the vehicle as soon as possible after it has been driven in an environment containing salt.



CAUTION:

It is best to clean the vehicle only with water and mild detergents or special cleaners provided by the professional dealers. Acidic cleaners are prohibited from cleaning the vehicle. If such acidic cleaner are used accidentally, please clean the area immediately to avoid damage to the vehicle. Then, use a dry towel or sponge to dry the vehicle.

Please always follow the care and cleaning instructions provided by the manufacturer.



WARNING:

Do not use high-pressure water guns or steam cleaners to clean the vehicle. This may cause water to enter bearings or electrical components, such as connections, switches or lighting, and may cause damage to brake pads, seals, paint or other parts.



CLEANING AND STORAGE



CAUTION:

Salt is of extreme corrosion

Therefore, these cleaning instructions shall be abided by: wait for the motor to be cooled, as well as use water and a mild detergent. Clean all metals and then treat parts with rust inhibiting spray, including inscriptions and nickel plated parts

Clean the dirt with warm water, a mild detergent and a soft, clean sponge. Then rinse thoroughly with clean water. Use a small brush to clean hard-to-reach areas.

After cleaning

In order to avoid rusting, we recommend the use of a suitable care product.



WARNING:

Make sure that no cleaning agents and lubricants are left on the brake discs, which may cause the brake system to fail while the vehicle is in motion and cause safety accidents. If the brake system is contaminated with such substances, please remove them before use.

Store the vehicle for a long time (two weeks and more)

Clean the vehicle.

- Charge the battery to 20%~40% of its capacity according to the standard charging method and check the condition every 3 months at the latest. Follow the instructions in chapter "Routine maintenance".
- Check or adjust the tire pressure and lift the vehicle off the ground so that all wheels are not in contact with the ground. If this is not possible, rotate the tires every month to avoid damage caused by partial stress on the tires over time.



CLEANING AND STORAGE



CAUTION:

Always keep the battery charged. Storing a depleted battery will cause permanent damage to the battery



WARNING:

If you are not familiar with the battery, please contact a specialist dealer.



WARNING:

To avoid over-discharge of the battery, it is recommended to charge and discharge the battery once every 3 months according to the standard charging and discharging method, and then charge the battery to 20%~40% of its capacity according to the standard charging method.



WARNING:

Store the vehicle in a well-ventilated area. High humidity air can cause rust and corrosion.

Short-term storage of the vehicle (within two weeks)

Store the vehicle in a cool, dry place, protected by a tarpaulin if necessary.



WARRANTY

Standards regulating manufacturer **RIEJU'S** warranty.

The company RIEJU hereby guarantees the end consumer, purchaser of a vehicle manufactured by RIEJU, that both the materials and the manufacturing are free from defect, pursuant to the highest quality standards. Consequently, RIEJU hereby provides the end purchaser (hereinafter, the "purchaser"), pursuant to the conditions set forth below, with a warranty to repair all material or manufacturing defects found on a new motorcycle at no cost, within the established warranty period and with no limitation in terms of the number of kilometres travelled or the number of hours the vehicle has been operated.

Warranty Period

The warranty period shall be governed by warranty law in the vehicle's country of sale, in force at the time it is sold.



Warranty claims for defects not brought to the attention of a RIEJU-authorized dealer before the end of the warranty period shall be excluded.

Purchaser obligations

RIEJU may legitimately reject warranty claims if, and to the extent that:

- a) The purchaser has not brought the vehicle to any of the inspections and/or to undergo maintenance tasks as required in the user manual, or the date set for these inspections or maintenance tasks has passed. Also excluded from the warranty are defects that appear before the date established for an inspection or maintenance task that never occurred, or that will occur after the established date.
- b) Inspections, maintenance work, or repairs have been conducted by third parties not recognised or authorised by **RIEJU**.
- c) Any maintenance or repair has been conducted in violation of the technical requirements, specifications, and instructions set forth by the manufacture



WARRANTY

- d) Replacement parts not authorised for use by RIEJU have been used in maintenance or repair work on the vehicle, or if, and to the extent that, lubricants, or other liquids (including, but not limited to, cleaning products) that were not expressly mentioned in the User Manual's instructions have been used on or in the vehicle.
- e) The vehicle has been, in any way, altered or modified or fitted with components other than the components expressly authorised by **RIEJU** as components allowed for the vehicle.
- f) The vehicle has been stored or transported in a way that is contrary to technical requirements.
- g) The vehicle has been used for a special use other than ordinary use, such as competition, racing, or in an attempt to beat a record.
- h) The vehicle has suffered a fall or accident that directly or indirectly causes damages.

Warranty exclusions

The following articles are excluded from the warranty:

- a) Replacements for wear, including, but not limited to, batteries, chains (secondary), engine output pinions, rear rings, brake discs, brake pads, bulbs, fuses, carbon brushes, footrest rubber, tyres, chambers, wires, and other rubber components.
- b) Lubricants (for example, oil, grease, etc.).
- c) Inspection, adjustment, and other maintenance work, as well as all kinds of cleaning work.
- d) Damage to the paint and consequent rust due to external influences, such as rocks, salt, industrial fumes, and other environmental impacts, or inadequate cleaning with inadequate products.
- e) Damages caused by defects, as well as expenses caused directly or indirectly by the defects (for example, communications expenses, lodging expenses, car hire expenses, public transport expenses, recovery vehicle expenses, emergency messenger expenses, etc.) as well as other financial harm (for example, caused by loss of use of a vehicle, lost income, lost time, etc.).
- f) Acoustic or aesthetic circumstances that do not significantly affect conditions for use of the motorcycle (for example, small or hidden imperfections, normal noise or vibration in use, etc.).



WARRANTY

g) Circumstances due to vehicle ageing (for example, fading of painted surfaces or metal coating).

Miscellaneous

a) If repair of the defect or replacing the part is disproportionate, **RIEJU** shall be entitled to decide, at its sole discretion, whether to repair or replace the defective parts. Ownership over the replaced parts, if applicable, shall be held by **RIEJU**, with no other consideration. The dealer authorised by **RIEJU** whom has been entrusted to repair defects shall not be authorised to make binding statements on **RIEJU'S** behalf.

b) If there is doubt as to whether there is a defect or a visual or material inspection is required, **RIEJU** reserves the right to require that the parts being claimed under the warranty be sent to it, or to request that a **RIEJU** expert examine them. Any additional warranty obligations for replaced parts at no cost or for any services provided at no cost under this warranty shall be excluded. The warranty for replaced components during the warranty period shall end on the expiry date of the warranty period of the respective product.

c) If a defect cannot be repaired and its replacement is disproportionate for the manufacturer, the consumer under warranty shall be entitled to cancellation of the contract (payment of a compensation) or partial reimbursement of the purchase price (discount) instead of motorcycle repair.

d) The purchaser's warranty claims under the purchase-sale contract with the authorised dealer shall not be affected by this warranty. This warranty shall not affect the purchaser's additional contractual rights under the general business conditions of the authorised dealer. However, said additional rights may only be claimed with the authorised dealer.

e) If the purchaser resells the product during the warranty period, the terms and conditions of this warranty shall continue to exist under their current scope, such that rights to claim pursuant to this warranty under the terms and conditions governed by this document shall be transferred to the new owner of the motorcycle.



RIEJU®
...for everyday adventure